



WTB4S-3P2465V

W4

MINIATURE PHOTOELECTRIC SENSORS

SICK
Sensor Intelligence.



Illustration may differ

Ordering information

| Type | Part no. |
|---------------|----------|
| WTB4S-3P2465V | 1096885 |

Other models and accessories → www.sick.com/W4



Detailed technical data

Features

| | |
|------------------------------------|--------------------------------|
| Functional principle | Photoelectric proximity sensor |
| Functional principle detail | Background suppression |
| Sensing range max. | 4 mm ... 500 mm ¹⁾ |
| Sensing range | 10 mm ... 350 mm ¹⁾ |
| Emitted beam | |
| Light source | PinPoint LED ²⁾ |
| Type of light | Visible red light |
| Light spot size (distance) | Ø 6.5 mm (150 mm) |
| Key LED figures | |
| Wave length | 650 nm |
| Adjustment | Cable ³⁾ |
| Special applications | Hygienic and washdown zones |
| Housing design | Washdown |

¹⁾ Object with 90% remission (based on standard white, DIN 5033).

²⁾ Average service life: 100,000 h at T_U = +25 °C.

³⁾ External teach-in: pulse > 2 s with voltage U_v with PNP and M with NPN.

Safety-related parameters

| | |
|-------------------------|-------------|
| MTTF_D | 1,211 years |
| DC_{avg} | 0 % |

| | |
|-------------------------------------|----------|
| T_M (mission time) | 20 years |
|-------------------------------------|----------|

Electronics

| | |
|-------------------------------------|---|
| Supply voltage U_B | 10 V DC ... 30 V DC ¹⁾ |
| Ripple | < 5 V _{pp} ²⁾ |
| Current consumption | 30 mA ³⁾ |
| Protection class | III |
| Digital output | |
| Type | PNP |
| Switching mode | Light switching |
| Output current I _{max.} | ≤ 100 mA |
| Response time | < 0.5 ms ⁴⁾ |
| Switching frequency | 1,000 Hz ⁵⁾ |
| Circuit protection | A ⁶⁾ B ⁷⁾ C ⁸⁾ |

¹⁾ Limit values, reverse-polarity protected, operation in short-circuit protected network: max. 8 A.

²⁾ May not fall below or exceed U_y tolerances.

³⁾ Without load.

⁴⁾ Signal transit time with resistive load.

⁵⁾ With light/dark ratio 1:1.

⁶⁾ A = V_S connections reverse-polarity protected.

⁷⁾ B = inputs and output reverse-polarity protected.

⁸⁾ C = interference suppression.

Mechanics

| | |
|-------------------------------|---|
| Housing | Rectangular |
| Design detail | Slim |
| Dimensions (W x H x D) | 15.25 mm x 49.2 mm x 22.2 mm |
| Connection | Male connector M12, 4-pin ¹⁾ |
| Material | |
| Housing | Metal, Stainless steel V4A (1.4404, 316L) |
| Front screen | Plastic, PMMA |
| Weight | 45 g |

¹⁾ Max. tightening torque: 0.7 Nm.

Ambient data

| | |
|--------------------------------------|--|
| Enclosure rating | IP66 IP67 IP68 IP69K |
| Ambient operating temperature | -30 °C ... +70 °C ¹⁾ -30 °C ... +60 °C |
| Ambient temperature, storage | -30 °C ... +75 °C |
| UL File No. | NRKH.E181493 & NRKH7.E181493 |

¹⁾ At UV ≤ 24 V and IA < 30 mA.

Classifications

| | |
|-----------------------|----------|
| ECLASS 5.0 | 27270904 |
| ECLASS 5.1.4 | 27270904 |
| ECLASS 6.0 | 27270904 |
| ECLASS 6.2 | 27270904 |
| ECLASS 7.0 | 27270904 |
| ECLASS 8.0 | 27270904 |
| ECLASS 8.1 | 27270904 |
| ECLASS 9.0 | 27270904 |
| ECLASS 10.0 | 27270904 |
| ECLASS 11.0 | 27270904 |
| ECLASS 12.0 | 27270903 |
| ETIM 5.0 | EC002719 |
| ETIM 6.0 | EC002719 |
| ETIM 7.0 | EC002719 |
| ETIM 8.0 | EC002719 |
| UNSPSC 16.0901 | 39121528 |

Connection type

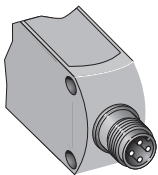

Connection diagram

Cd-092

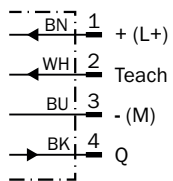

Characteristic curve

WTB4S-3, 500 mm

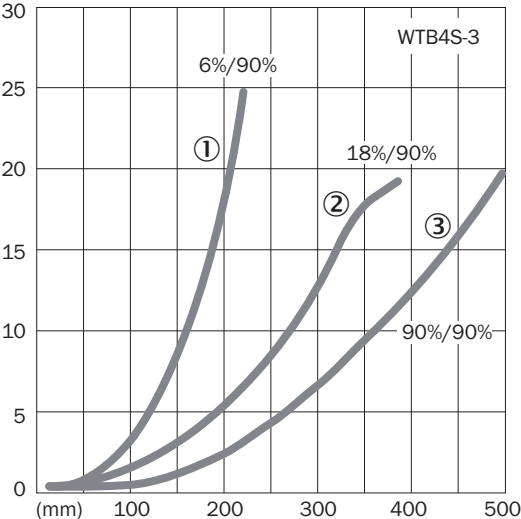

- ① Sensing range on black, 6% remission factor
- ② Sensing range on gray, 18% remission factor
- ③ Sensing range on white, 90% remission factor

Sensing range diagram

WTB4S-3, 500 mm

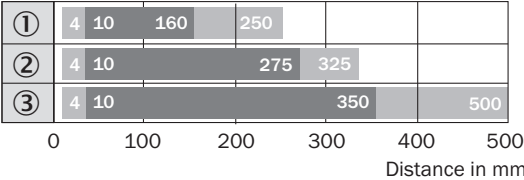

- Sensing range ■ Sensing range max.
- ① Sensing range on black, 6% remission factor
- ② Sensing range on gray, 18% remission factor
- ③ Sensing range on white, 90% remission factor

Dimensional drawing (Dimensions in mm (inch))

WTB4S-3V, WTF4S-3V, without single teach-in button

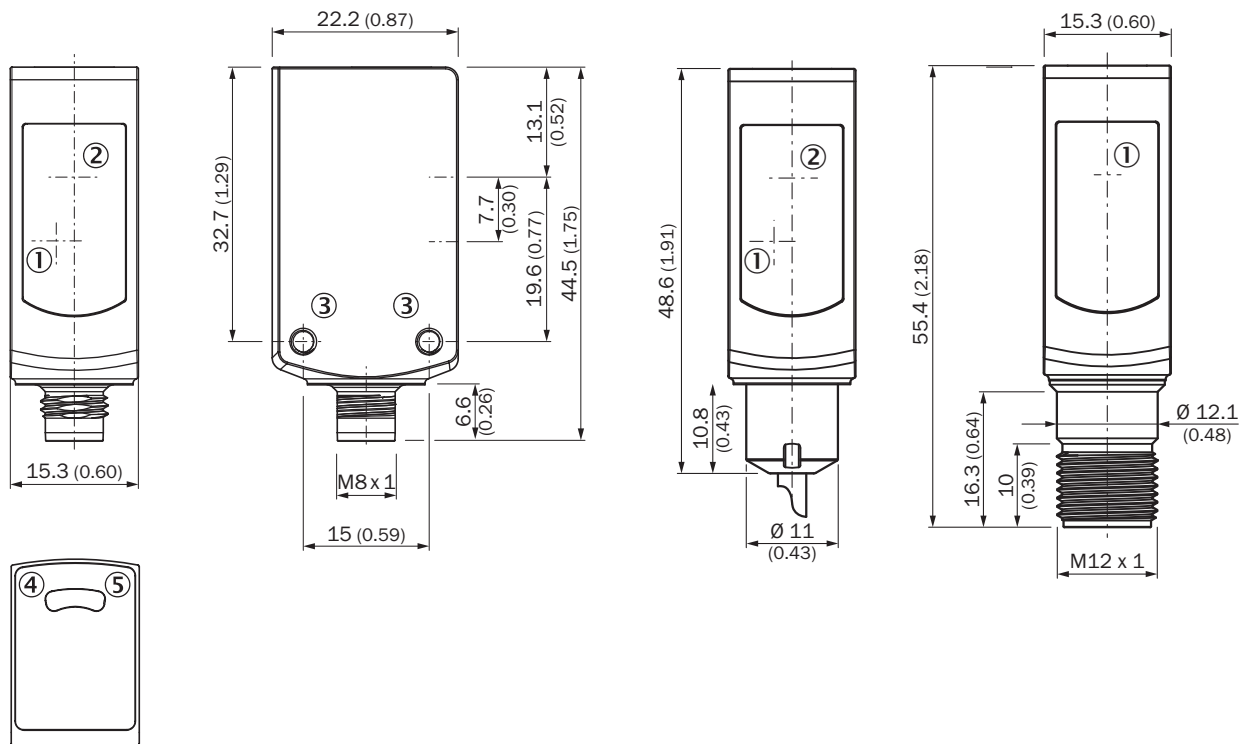

- ① Center of optical axis, receiver
- ② Center of optical axis, sender
- ③ Threaded mounting hole M3
- ④ LED indicator yellow: Status of received light beam
- ⑤ LED indicator green: Supply voltage active

Recommended accessories

Other models and accessories → www.sick.com/W4

| | Brief description | Type | Part no. |
|---|---|----------|----------|
| Others | | | |
|  | <ul style="list-style-type: none"> • Product family: Brackets • Description: Mounting bracket for floor mounting • Material: Stainless steel • Details: Stainless steel 1.4571 • Items supplied: Mounting hardware included • Suitable for: W4S, W4F, W4S | BEF-W4-B | 2051630 |

| | Brief description | Type | Part no. |
|---|---|-----------------|----------|
|  | <ul style="list-style-type: none"> • Connection type head A: Female connector, M12, 4-pin, straight • Connection type head B: Flying leads • Signal type: Sensor/actuator cable • Cable: 5 m, 4-wire, PP • Description: Sensor/actuator cable, unshielded • Connection systems: Flying leads • Note: This product is generally resistant to chemical cleaning agents (see ECOLAB) and other chemical compounds such as H2O2 and CH2O2. Before permanent installation is carried out, the material's resistance to the cleaning agent being used must be checked., Resistant against lactic acid & hydrogen peroxide (H2O2) • Application: Hygienic and washdown zones, Drag chain operation | DOL-1204-G05MRN | 6058476 |

SICK AT A GLANCE

SICK is one of the leading manufacturers of intelligent sensors and sensor solutions for industrial applications. A unique range of products and services creates the perfect basis for controlling processes securely and efficiently, protecting individuals from accidents and preventing damage to the environment.

We have extensive experience in a wide range of industries and understand their processes and requirements. With intelligent sensors, we can deliver exactly what our customers need. In application centers in Europe, Asia and North America, system solutions are tested and optimized in accordance with customer specifications. All this makes us a reliable supplier and development partner.

Comprehensive services complete our offering: SICK LifeTime Services provide support throughout the machine life cycle and ensure safety and productivity.

For us, that is “Sensor Intelligence.”

WORLDWIDE PRESENCE:

Contacts and other locations – www.sick.com